

12

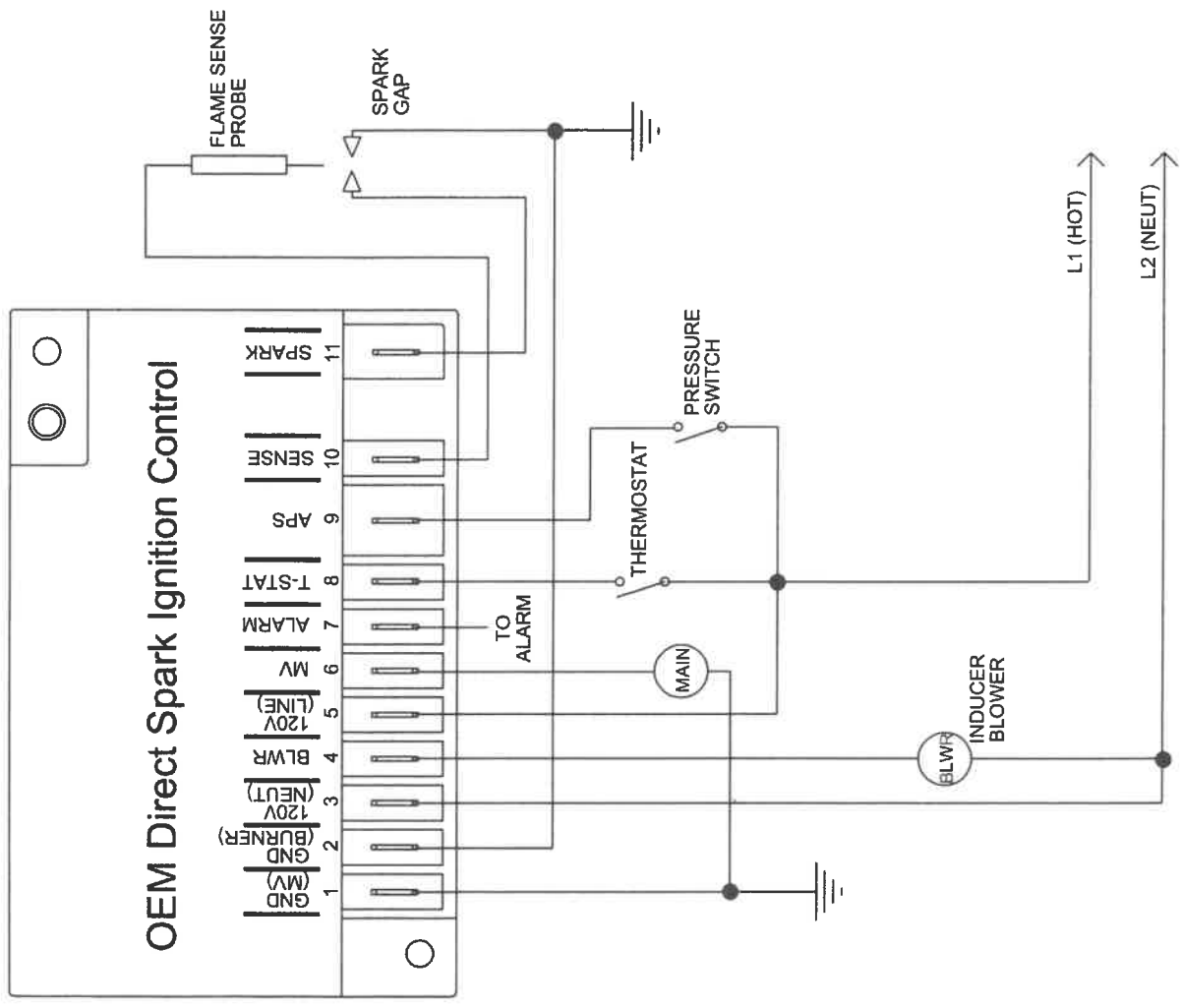

FIG.19 TYPICAL WIRING, HARDWARE TYPE 58,60,62,64